

*Superstikls*

Furnitūra Pilnstiklam

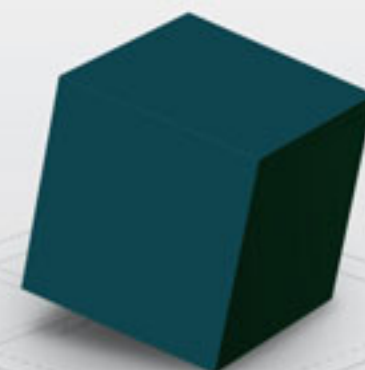

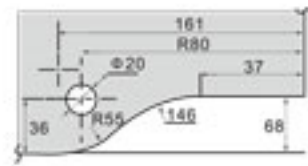
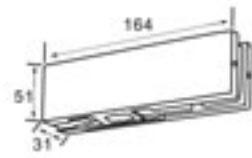

**IPF-10**

Zinc Alloy/ Aluminium casting body, Stainless Steel Cover  
Fit for 10-12mm Glass

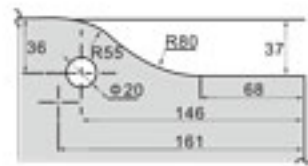
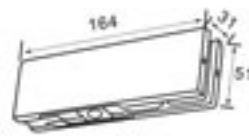

**IPF-20**

Zinc Alloy/ Aluminium casting body, Stainless Steel Cover  
Fit for 10-12mm Glass

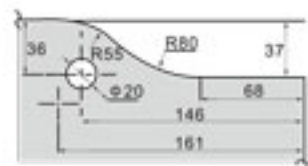

**IPF-30**

Zinc Alloy/ Aluminium casting body, Stainless Steel Cover  
Fit for 10-12mm Glass

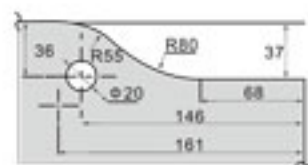
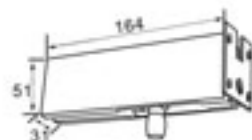

**IPF-30W**

Zinc Alloy/ Aluminium casting body, Stainless Steel Cover  
Fit for 10-12mm Glass

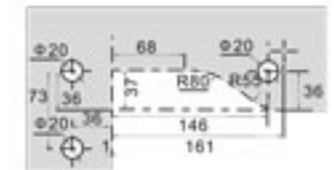
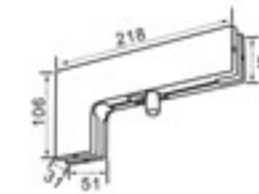

**IPF-40**

Zinc Alloy/ Aluminium casting body, Stainless Steel Cover  
Fit for 10-12mm Glass

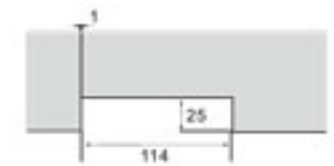
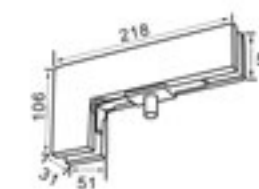

**IPF-40W**

Zinc Alloy/ Aluminium casting body, Stainless Steel Cover  
Fit for 10-12mm Glass

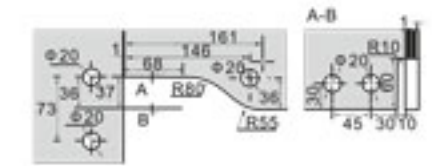
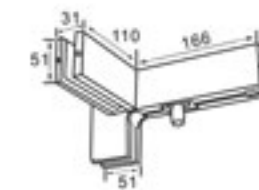

**IPF-41**

Zinc Alloy/ Aluminium casting body, Stainless Steel Cover  
Fit for 10-12mm Glass

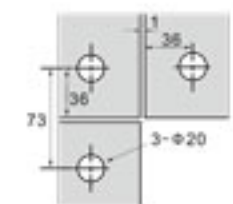
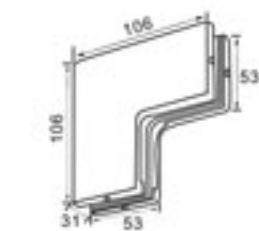

**IPF-60**

Zinc Alloy/ Aluminium casting body, Stainless Steel Cover  
Fit for 10-12mm Glass



**IPF-70**

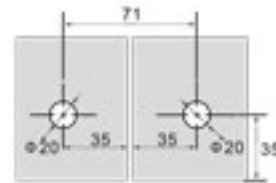
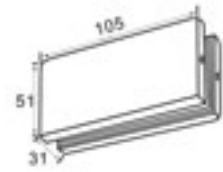

Zinc Alloy/ Aluminium casting body, Stainless Steel Cover  
Fit for 10-12mm Glass



**IPF-GK20**

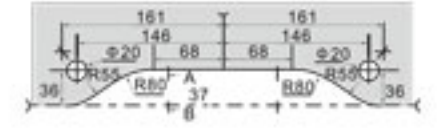

Zinc Alloy/ Aluminium casting body, Stainless Steel Cover  
Fit for 10-12mm Glass



**IPF-80**

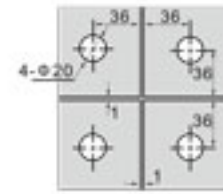

Zinc Alloy/ Aluminium casting body, Stainless Steel Cover  
Fit for 10-12mm Glass



**IPF-US10P**

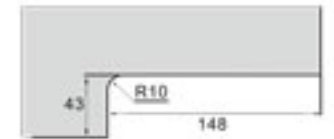
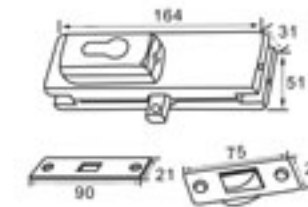

Zinc Alloy/ Aluminium casting body, Stainless Steel Cover  
Fit for 10-12mm Glass



**IPF-90**

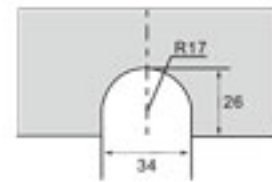
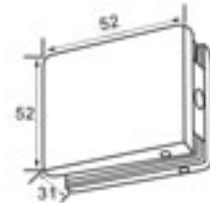

Zinc Alloy/ Aluminium casting body, Stainless Steel Cover  
Fit for 10-12mm Glass



**IPF-24**

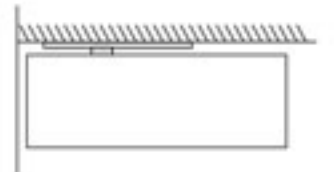
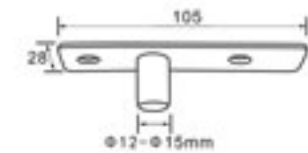

Stainless Steel 304



**IPF-B01**

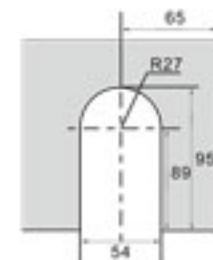
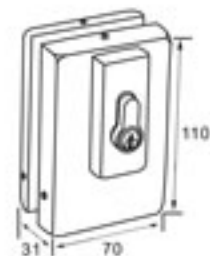

Zinc Alloy/ Aluminium casting body, Stainless Steel Cover  
Fit for 10-12mm Glass



**IPF-US20**

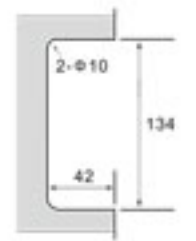

Zinc Alloy/ Aluminium casting body, Stainless Steel Cover  
Fit for 10-12mm Glass





**IPF-GK30**

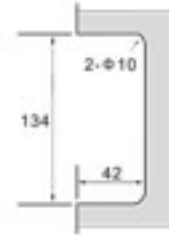
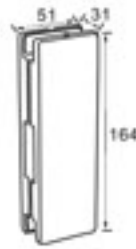

Zinc Alloy/ Aluminium casting body, Stainless Steel Cover  
Fit for 10-12mm Glass



**IPF-GK40**

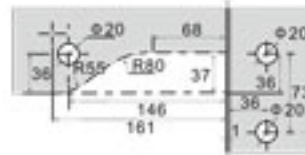
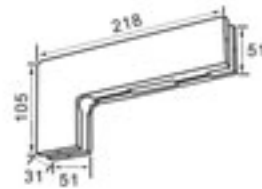

Zinc Alloy/ Aluminium casting body, Stainless Steel Cover  
Fit for 10-12mm Glass



**IPF-L01**

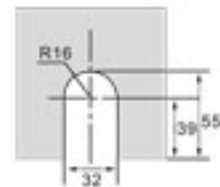
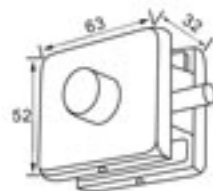

Zinc Alloy/ Aluminium casting body, Stainless Steel Cover  
Fit for 10-12mm Glass



**Bifold glass door lock**



**IM-HG-3**

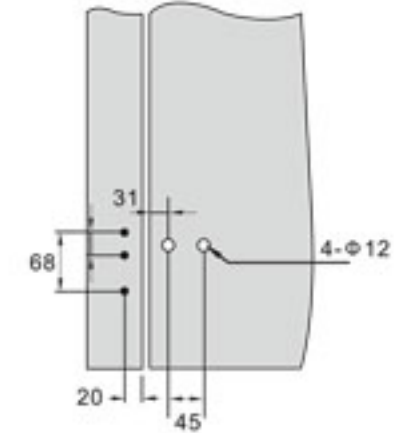

Bifold hinge  
Material: Stainless steel cover and Aluminum body



**IM-LC-1**

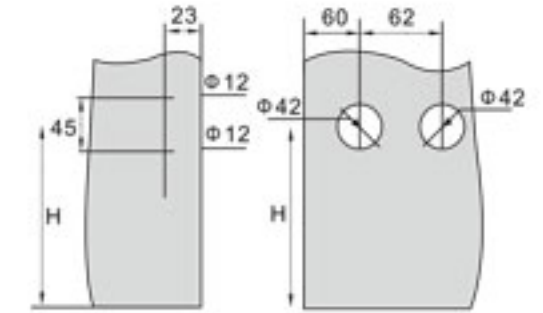

Glass to glass lock with stainless steel cover



**IM-LC-2**

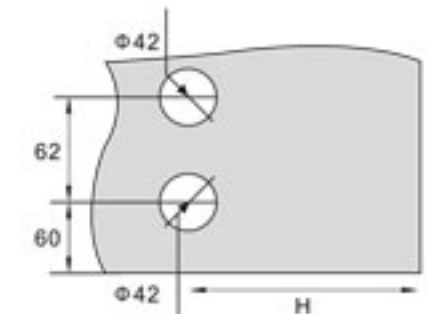

Glass to wall lock with stainless steel cover

## IM-G series sliding door system



**IM-G-1 (One Set)**

Sliding Door Hanger  
The maximum weight 100kg



**IM-G-2 (One Set)**

Sliding Door Hanger  
The maximum weight 100kg

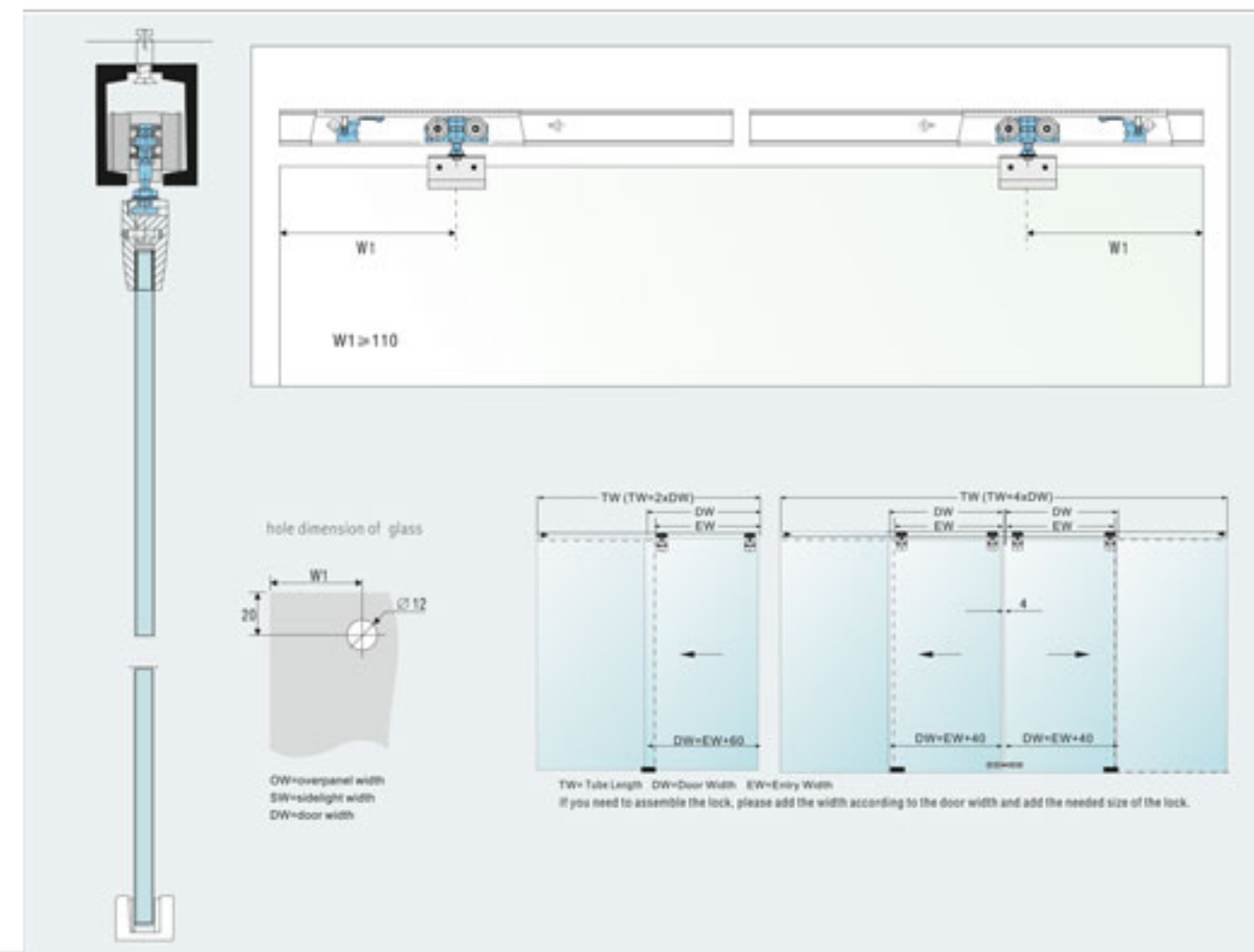
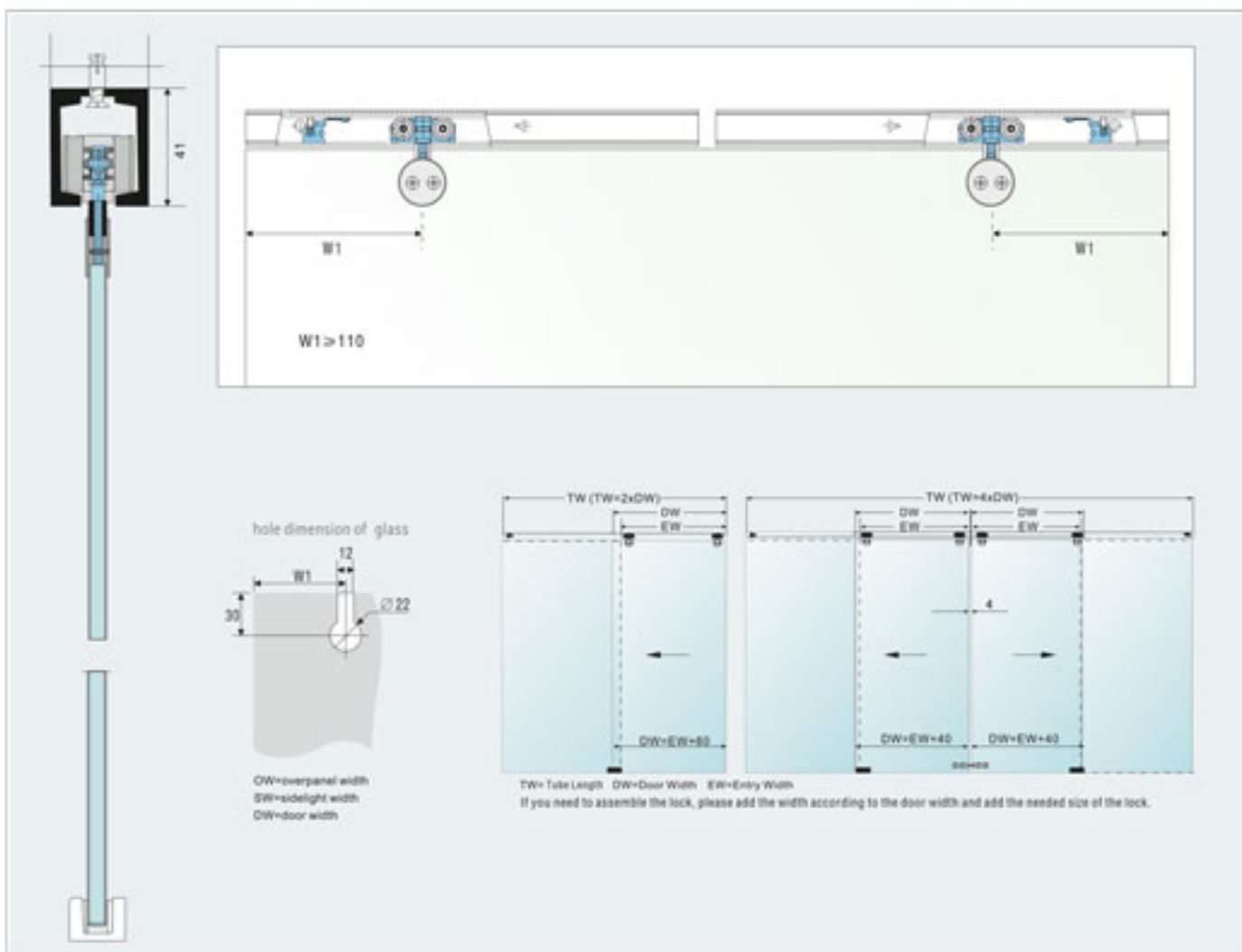



**IM-G series sliding door system**



**IM-G-3**  
Single track

**IM-G-4**  
One side fix panel track

**IM-G-5**  
Double track

**Accessories**



**IM-G-6**  
Door Stopper

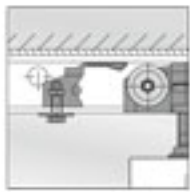

**IM-G-7**  
Track end cover

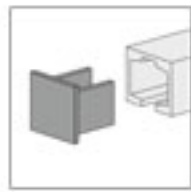

**IM-G-8**  
Track to wall hanger

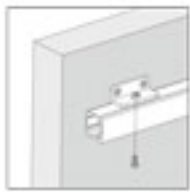

**IM-G-9**  
Track to Fix glass panel hanger

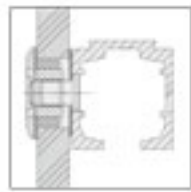

**IM-G-10**  
Track to Fix glass panel hanger



**IM-G-11**  
Track to wall connector

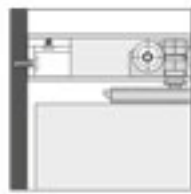

**IM-G-12**  
90° connector of top track

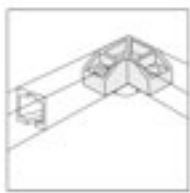

**IM-O-13**  
Floor guide



**IM-G series sliding door system:**  
Offering full ranges of glass sliding door solution  
Max carrying weight up to 100KGS  
Sliding door could fix on the wall; roof and glass panel.

**IM-H-4**

Hole dimension of glass    Hole dimension of glass

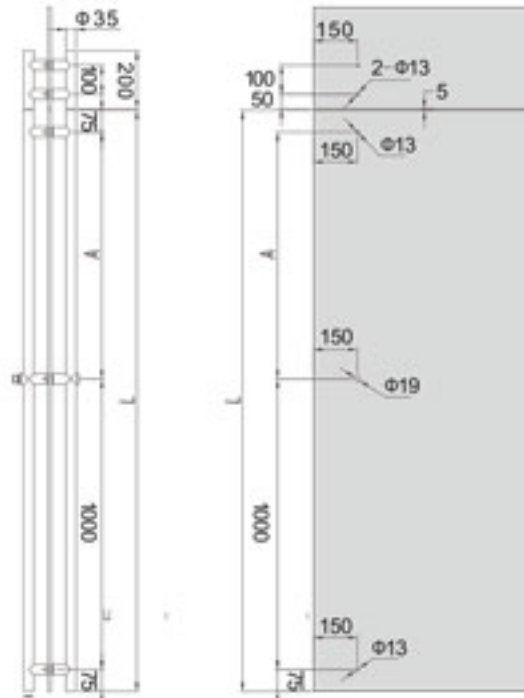

**IM-H-5**

Hole dimension of glass    Hole dimension of glass

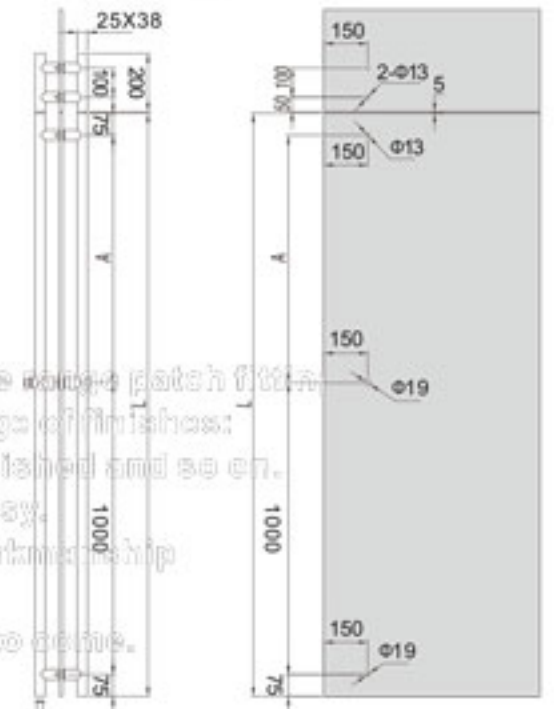

ility, and wide range patch fitting  
 a wide range of finishes:  
 shed PVD finished and so on.  
 quick and easy.  
 thorough workmanship  
 ve for years to come.



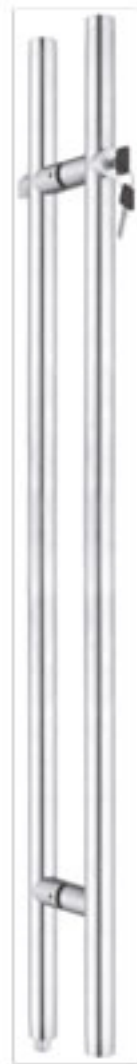

IM-H-3

Hole dimension of glass    Hole dimension of glass

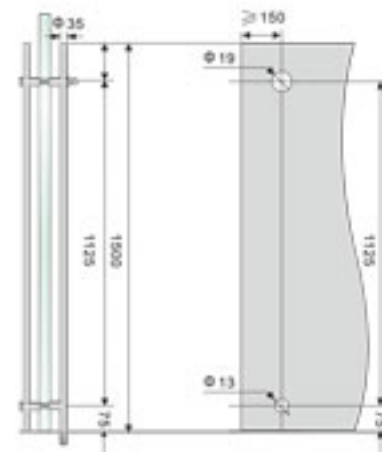

## Floor Spring



IBTS-84

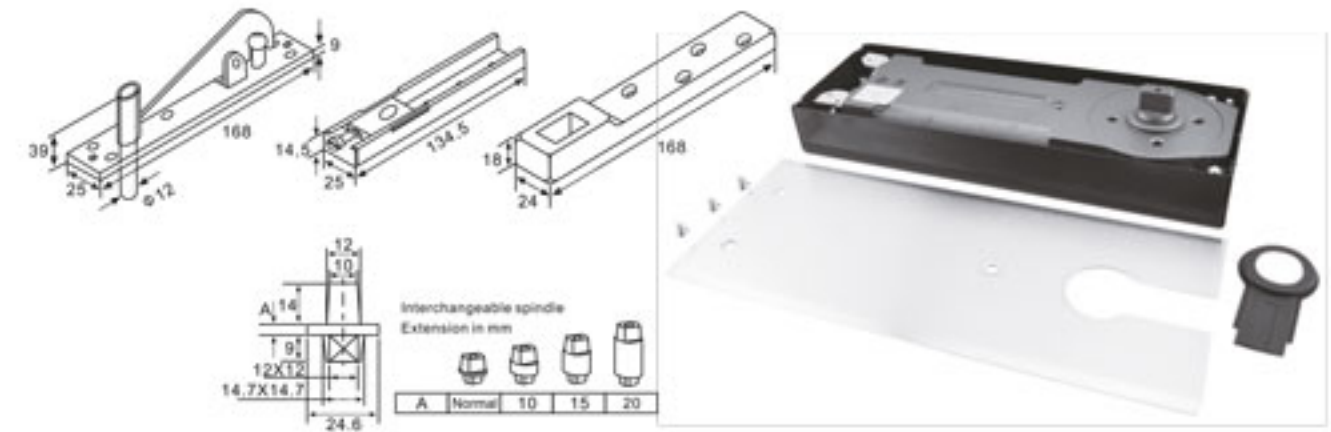
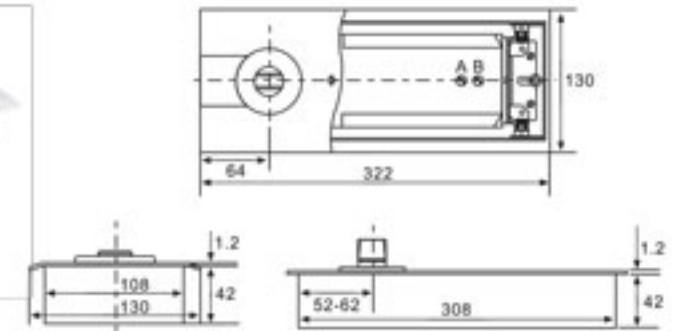

			Choice
Closing force	34Nm		25
Suitable for maximum wide door leaf	≤1200mm		—
The maximum bearing weight	110kg		—
The door closed speed is controlled by the adjusting valve	—		●
Opening angle	90°		●
Weight	6.5kg		—
Container Size	Length	308mm	—
	Width	108mm	
	Height	42mm	
The products have passed national Fire Rated Test; En1154 Test and CE Certificate	5 lakh Cycles		●

● Yes    — No    ○ Choice





- Door Handles are manufactured by using heavy wall high grade Brass and SUS 316/304 Stainless steel tubing, precision bending, cutting & welding process and polished meticulously try to meet industry standards.

- Available Finishes:

**Brass:**

CH: Chrome

BN: Brushed Nickel

ORB: Oil Rubbed Bronze

TP: Titanium Plated (PVD coated as Gold color but never change)

**SUS316/304:**

PSS: Polished Stainless Steel.

SSS: Satin Stainless Steel.

ORB: Oil Rubbed Bronze

TP: Titanium Plated (PVD coated as Gold color but never change)

- Connector construction For Glass Door / Wooden Door

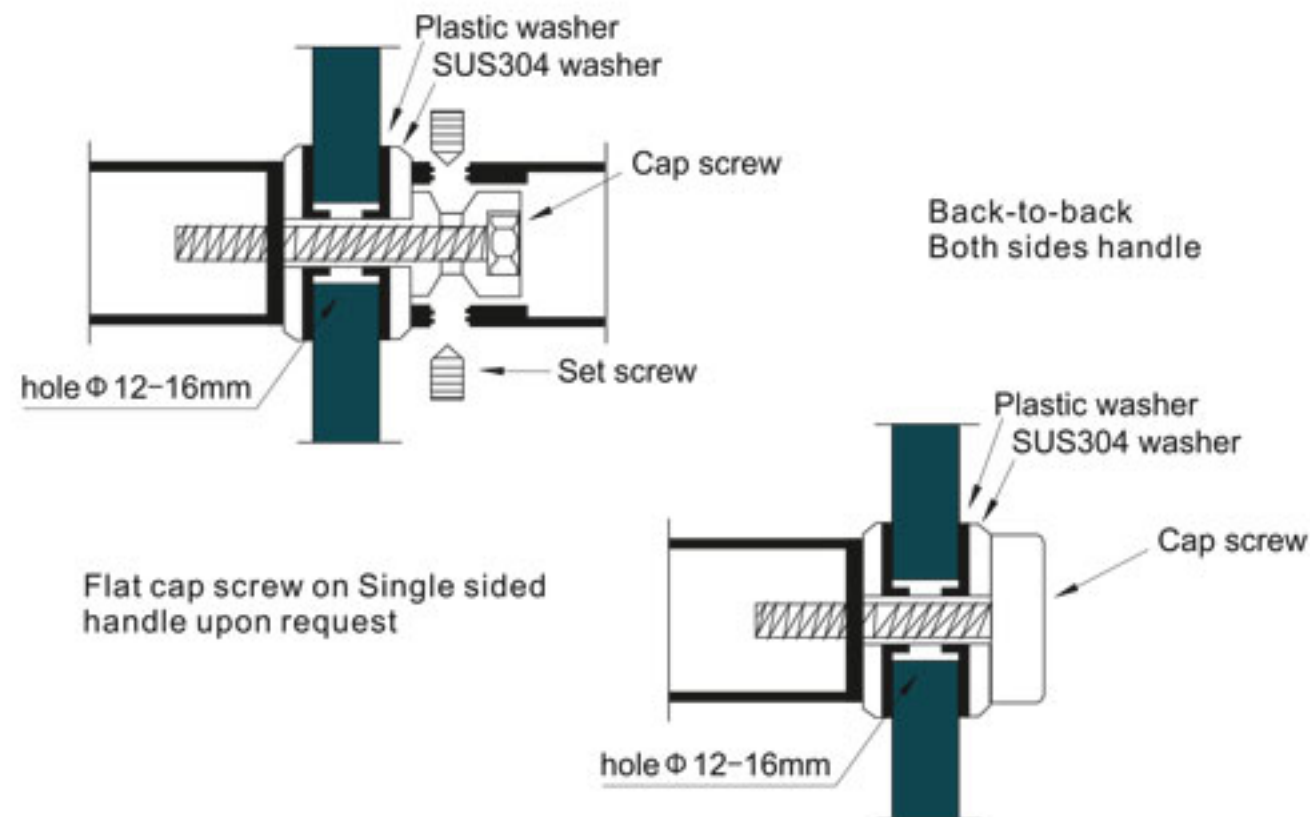

Longer Screw for wooden doors, aluminum doors, steel doors available by order.

## HANDLE

Our door handle are manufactured by high quality SUS316 or SUS304 stainless steel and Brass.

All the handle with high quality finished and construction.





■ All INF Pulls and Towel Bar Sets are constructed of heavy wall Brass tubing and SUS 316/304 stainless steel tubing. Tubing Diameter: 19mm(3/4"); 25mm(1")

■ Fits glass thickness from 6mm(1/4") to 12mm(1/2")

■ Available Finishes:

**Brass:**

CH: Chrome

BN: Brushed Nickel

ORB: Oil Rubbed Bronze

TP: Titanium Plated (PVD coated as Gold color but never change)

**SUS316/304:**

PSS: Polished Stainless Steel.

SSS: Satin Stainless Steel.

ORB: Oil Rubbed Bronze

TP: Titanium Plated (PVD coated as Gold color but never change)



ISH-01S

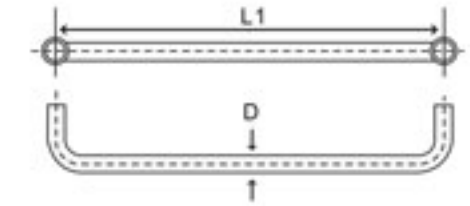

ISH-01SK

	L1(C/C)	D m/m
A	152(6")	19(3/4")/25(1")
B	203(8")	19(3/4")/25(1")
C	254(10")	19(3/4")/25(1")
D	305(12")	19(3/4")/25(1")
E	457(18")	19(3/4")/25(1")
F	Customer size are available	



ISH-01SS

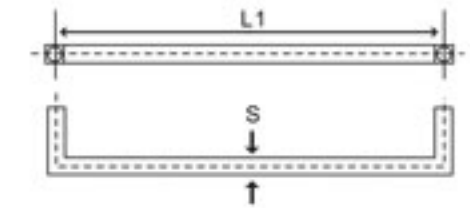

ISH-01SKS

	L1(C/C)	S m/m
A	305(12")	25 X 25
B	457(18")	25 X 25
C	610(24")	25 X 25
D	400	25 X 25
E	600	25 X 25
F	Customer size are available	



ISH-01

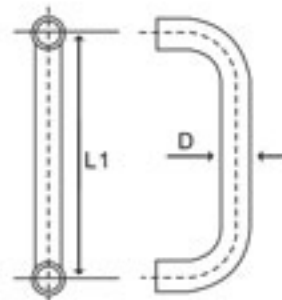

	L1(C/C)	D m/m
A	152(6")	19(3/4")/25(1")
B	203(8")	19(3/4")/25(1")
C	254(10")	19(3/4")/25(1")
D	305(12")	19(3/4")/25(1")
E	457(18")	19(3/4")/25(1")
F	Customer size are available	



**ISH-12**

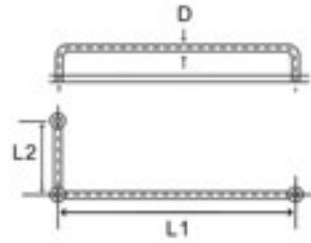

	L1(C/C)	L2(C/C)mm	D m/m
<b>A</b>	152(6")	406(16")	19(3/4")/25(1")
<b>B</b>	203(8")	457(18")	19(3/4")/25(1")
<b>C</b>	254(10")	508(20")	19(3/4")/25(1")
<b>D</b>	305(12")	559(22")	19(3/4")/25(1")
<b>E</b>	203(8")	609(24")	19(3/4")/25(1")
<b>F</b>	Customer size are available		



**IH-01**

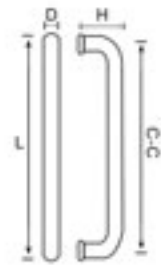

	L	C-C	H	D
<b>A</b>	169	150	70	19
<b>B</b>	219	200	70	19
<b>C</b>	319	300	70	19
<b>D</b>	475	450	70	25
<b>E</b>	525	500	70	25
<b>F</b>	Customer size are available			



**IH-04**

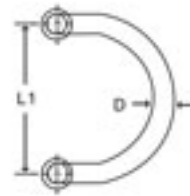

	L1(C/C)	D
<b>A</b>	200	25
<b>B</b>	200	32
<b>C</b>	250	32
<b>D</b>	305	25
<b>E</b>	305	32
<b>F</b>	350	32



**IH-13**

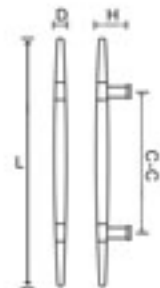

	L	C-C	H	D
<b>A</b>	600	300	75	32
<b>B</b>	800	400	78	38



**IH-14**

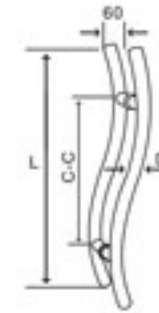

	L	C-C	H	D
<b>A</b>	400	300	62	22
<b>B</b>	600	400	72	32
<b>C</b>	800	600	80	38



**IH-15**



	L	C-C	H	D
<b>A</b>	169	150	70	19
<b>B</b>	219	200	70	19
<b>C</b>	319	300	70	19
<b>D</b>	475	450	70	25
<b>E</b>	525	500	70	25
<b>F</b>	482	450	72	32
<b>G</b>	632	600	72	32
<b>H</b>	Customer size are available			



**IH-16**



	L	C-C	H	D
<b>A</b>	450	300	67	25
<b>B</b>	450	300	72	32
<b>C</b>	600	400	72	32
<b>D</b>	600	400	80	38
<b>E</b>	1000	800	72	32
<b>F</b>	1800	1600	80	38
<b>G</b>	Customer size are available			



**IH-19**

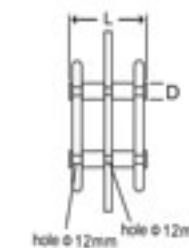

L	D
102	25
Customer size are available	



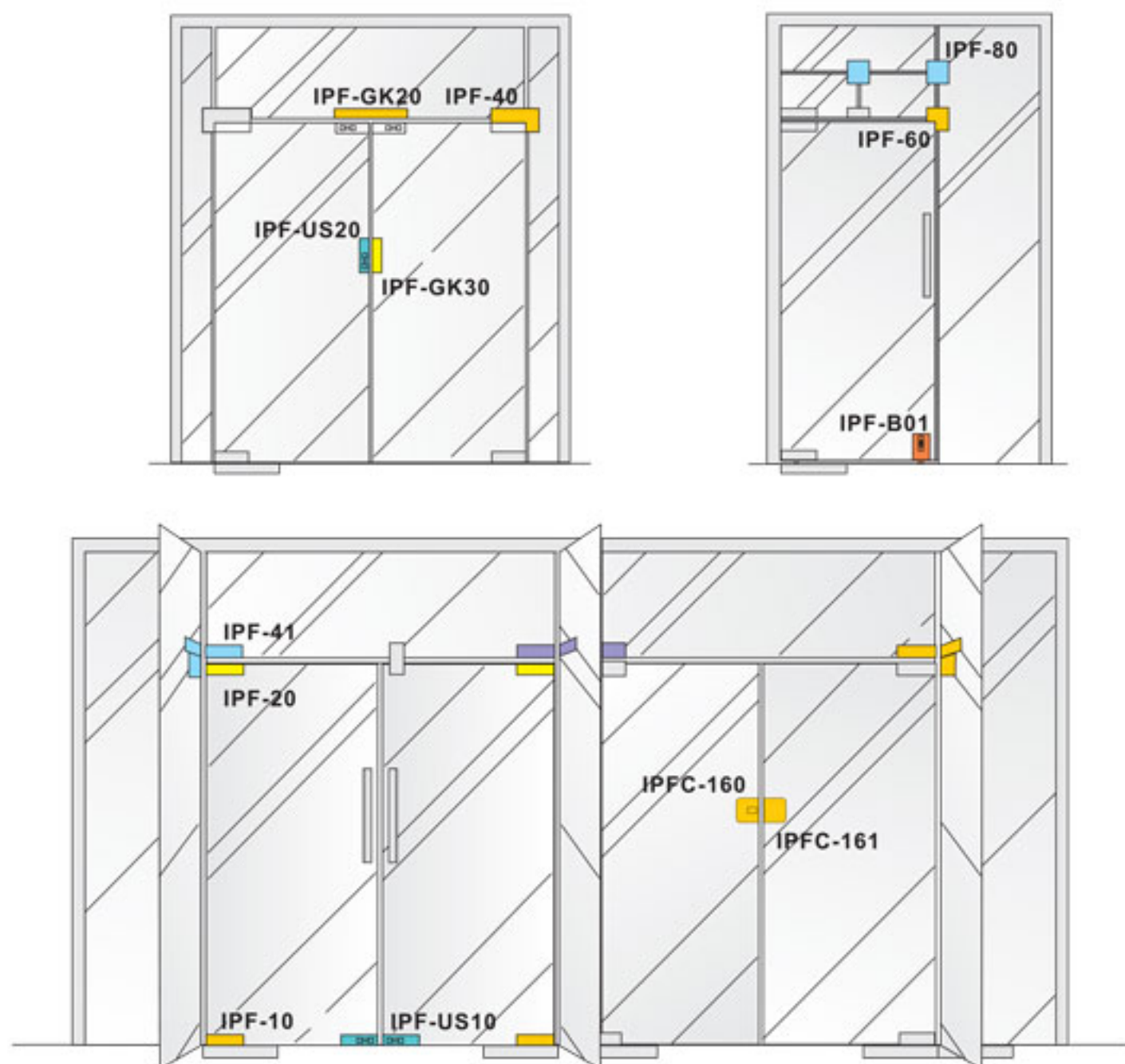

„DEBI” SIA  
LV50103895901  
Rušonu iela 28, Rīga, LV - 1057  
Tel. 29272368, E-pasts info@superstikls.lv  
www.superstikls.lv